



ACCESORIOS ISO-UNI
PVC-U

Accesorios para encolar, serie métrica

ACCESORIOS ISO-UNI

Serie de accesorios destinados al transporte de fluidos bajo presión con sistema de unión mediante soldadura química en frío (encolado) a través del uso de cola y limpiador.

ACCESORIOS PARA ENCOLAR, SERIE MÉTRICA

Especificaciones técnicas	
Gama dimensional	d 12 ÷ d 500 (mm)
Presión nominal	PN 16 con agua a 20° C
Rango de temperatura	0° ÷ 60° C
Estándares de unión	Encolado: ISO 727, EN ISO 15493, DIN 8063, EN ISO 1452, ASTM D 2467, JIS K 6743, BS 4346-1. Unibles con tubos según ISO 161-1, EN ISO 1452, EN ISO 15493, DIN 8062, ASTM D1785, JIS K6741, BS 3505-3506. Embridado: DIN 2501, EN 1092-1
Referencias normativas	Criterios constructivos: EN ISO 1452, EN ISO 15493 Métodos y requisitos de las pruebas: EN ISO 1452, EN ISO 15493 Criterios de instalación: DVS 2204, DVS 2221, UNI 11242
Material accesorios	PVC-U
Material de las juntas	EPDM, FPM

DATOS TÉCNICOS

VARIACIÓN DE LA PRESIÓN EN FUNCIÓN DE LA TEMPERATURA

Para agua o fluidos no peligrosos para los cuales el material está clasificado como QUÍMICAMENTE RESISTENTE (expectativa de vida 25 años). En otros casos es necesaria una disminución adecuada de la presión nominal PN.

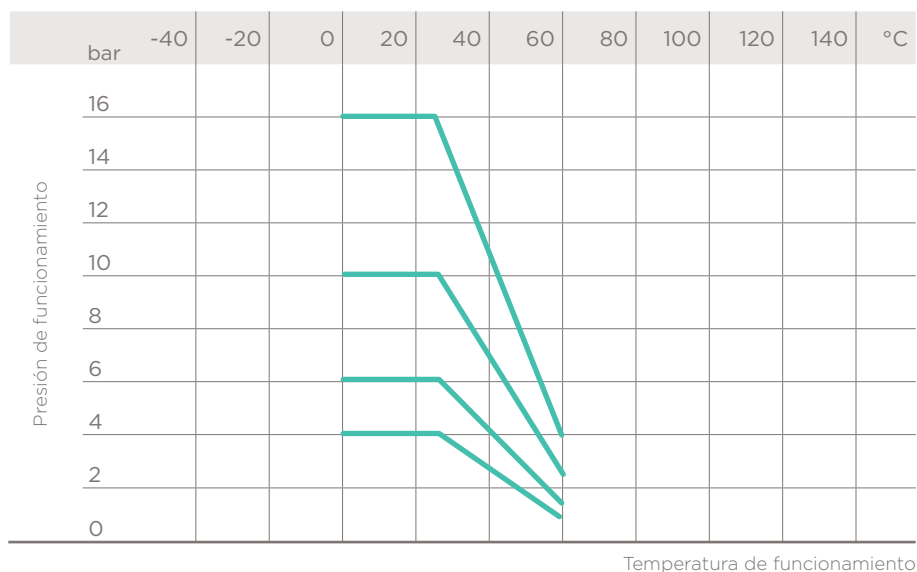

Temperatura de funcionamiento

CURVAS DE REGRESIÓN PARA ACCESORIOS DE PVC-U

Coefficientes de regresión según EN ISO 1452 y EN ISO 15493 para valores de MRS (mínimo) = 25 N/mm² (MPa) (clasificación PVC-U 250)

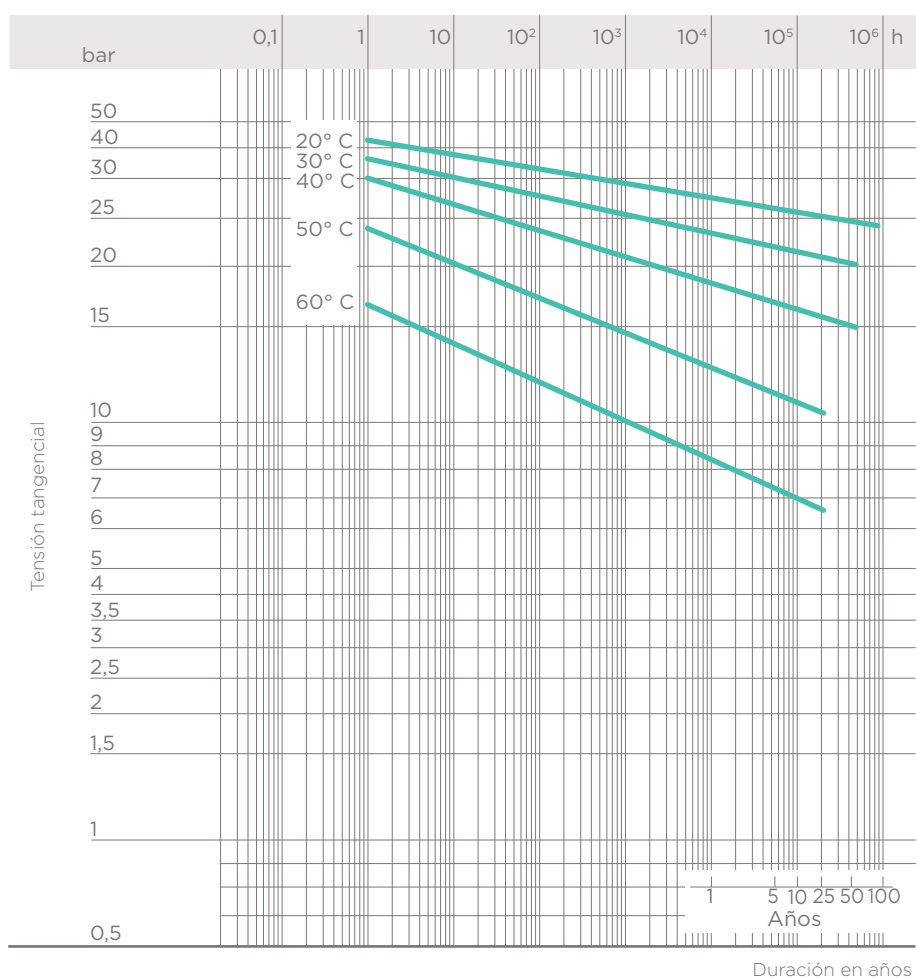

Duración en años

FACTORES DE SEGURIDAD

En la tabla se indican los factores de seguridad para cada clase de presión en función del tiempo.

Se considera presión nominal PN la presión convencional en base a la cual los accesorios se calculan y eligen para el empleo. La máxima presión de funcionamiento continua a 20° C en el transporte de agua debe ser igual al valor de las presiones nominales para asegurar la correspondencia con los valores de seguridad.

Salvo que se especifique otra cosa, las presiones nominales son las siguientes:

- accesorios para encolar
de d 12 a d 225 PN 16
de d 250 a d 315 PN 10
- accesorios mixtos
de d 16 a d 110 PN 16
- accesorios roscados
de R 3/8" a R 4" hasta PN 16.

Algunos accesorios de la gama se comercializan como PN16 con factor de seguridad reducido respecto de lo previsto por las referencias ISO.

Pf (bar)	1h	1000h	50 años	T
10	6,72	5,12	4	
16	4,2	3,2	2,5	
16*	3,3	2,5	2	

*con factor de seguridad reducido

DIMENSIONES

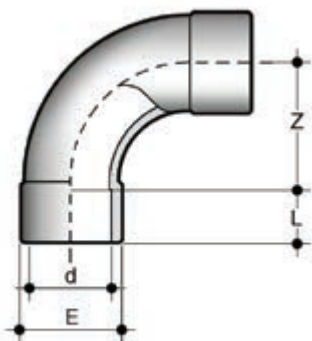

SIV

Curva a 90° radio grande ($R=2d$) con extremos para encolar hembra

	d	PN	E	L	Z	g	Código
IH	20	16	27	16	40,5	35	SIV020
IH	25	16	33	19	50	55	SIV025
IH	32	16	41	22	65,5	100	SIV032
IH	40	16	50	26	80,5	175	SIV040
IH	50	16	61	31	100,5	280	SIV050
IH	63	16	76	38	127	515	SIV063
I	75	16	94	44	150	1000	SIV075
I	90	16	113	51	180	1770	SIV090
I	110	16	137	61	220	2800	SIV110
I	*160	16	189	86	207	5020	SIV160

I: IIP 122 H: KIWA K5034 ND 10
*factor de seguridad reducido (PN 10)

Fig. A

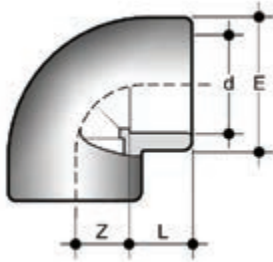

GIV

Codo a 90° con extremos para encolar hembra (fig. A)

	d	PN	E	L	Z	g	Código
	12	16	17	12	8	4	GIV012
IFH	16	16	22	14	9	11	GIV016
IFH	20	16	26	16	12	15	GIV020
IFH	25	16	32	19	15	30	GIV025
IFH	32	16	40	22	19	50	GIV032
IFH	40	16	50	26	22	90	GIV040
IFH	50	16	59	31	27,5	160	GIV050
IFH	63	16	76	38	33,5	290	GIV063
IF	75	16	91	44	41	450	GIV075
IF	90	16	108	51	47,5	680	GIV090
IF	110	16	130	61	61	1180	GIV110
IF	125	16	148	69	64	1650	GIV125
IF	140	16	163	76	77	2080	GIV140
IF	160	16	193	86	89	3980	GIV160
	*180	16	215	96	94	5200	GIV180
	*200	16	229	106	100	5360	GIV200

I: IIP 122 F: AFNOR NF04 H: KIWA K5034 ND 10
*factor de seguridad reducido

Fig. B

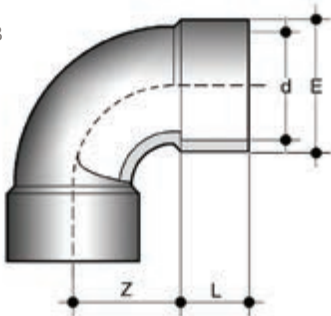

GIV

Codo a 90° con extremos para encolar hembra (fig. B)

d	PN	E	L	Z	g	Código
*225	16	258	119	171,5	8700	GIV225
250	10	287	131	188	12480	GIV250
280	10	325	147	210	17000	GIV280
315	10	359	164	236	23370	GIV315

*factor de seguridad reducido

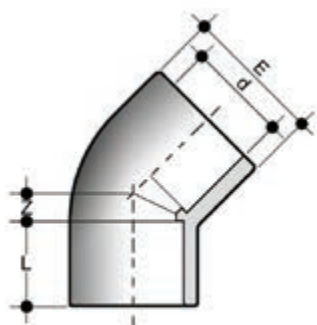

HIV

Codo a 45° con extremos para encolar hembra

	d	PN	E	L	Z	g	Código
	12	16	17	12	4	5	HIV012
	16	16	21	14	5	6	HIV016
IFH	20	16	28	16	5,5	20	HIV020
IFH	25	16	33	19	6	26	HIV025
IFH	32	16	41	22	7,5	45	HIV032
IFH	40	16	50	26	10,5	70	HIV040
IFH	50	16	61	31	11,5	120	HIV050
IFH	63	16	76	38	14	200	HIV063
IF	75	16	90	44	17	320	HIV075
IF	90	16	107	51	21,5	550	HIV090
I	110	16	130	61	26	915	HIV110
IF	125	16	147	69	31	1315	HIV125
IF	140	16	163	76	34	1660	HIV140
IF	160	16	192	86	38	3060	HIV160
	**180	4	208	97	38	3500	HIV180
	200	10	230	108	48	4500	HIV200
	225	10	260	121	55	6400	HIV225
	250	10	286	131	58	7700	HIV250
	280	10	320	146	62	10460	HIV280
	315	10	359	164	66	15500	HIV315

I: IIP 122 **F:** AFNOR NF04 **H:** KIWA K5034 ND 10
 **producto comercializado

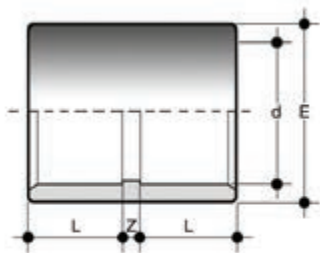

MIV

Manguito con extremos para encolar hembra

	d	PN	E	L	Z	g	Código
	12	16	17	12	3	3	MIV012
F	16	16	21	14	3	7	MIV016
HIF	20	16	26	16	3	11	MIV020
HIF	25	16	32	19	3	20	MIV025
HIF	32	16	40	22	3	30	MIV032
HIF	40	16	50	26	3	55	MIV040
HIF	50	16	61	31	3	90	MIV050
HIF	63	16	76	38	3	160	MIV063
IF	75	16	90	44	3	250	MIV075
IF	90	16	108	51	4	415	MIV090
IF	110	16	131	61	8	715	MIV110
IF	125	16	148	69	7	960	MIV125
IF	140	16	164	76	8	1240	MIV140
IF	160	16	186	86	9	1680	MIV160
	**180	4	209	96	8	2500	MIV180
	*200	16	232	106	11	3050	MIV200
	*225	16	260	119	11	4600	MIV225
	250	10	286	131	10	5760	MIV250
	280	10	320	146	10	7630	MIV280
	315	10	355	164	12	9780	MIV315

I: IIP 122 **F**: AFNOR NF04 **H**: KIWA K5034 ND 10

*factor de seguridad reducido

**producto comercializado

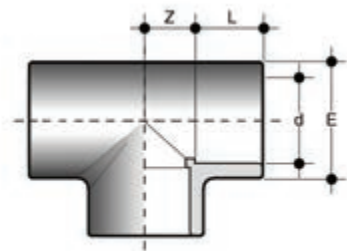

TIV

T a 90° con extremos para encolar hembra

	d	PN	E	L	Z	g	Código
	12	16	17	12	8	6	TIV012
FH	16	16	22	14	9	15	TIV016
IFH	20	16	27	16	11	25	TIV020
IFH	25	16	33	19	14	40	TIV025
IFH	32	16	40	22	18	65	TIV032
IFH	40	16	49	26	22	114	TIV040
IFH	50	16	61	31	27	185	TIV050
IFH	63	16	76	38	34	380	TIV063
IF	75	16	91	44	40,5	605	TIV075
IF	90	16	109	51	48,5	985	TIV090
IF	110	16	133	61	61	1760	TIV110
IF	125	16	151	69	64	2430	TIV125
IF	140	16	174	76	77	4150	TIV140
IF	160	16	193	86	88	5250	TIV160
	180	16	215	96	94	6180	TIV180
	*200	16	228	106	101	6810	TIV200
	*225	16	258	119	114	12680	TIV225
	250	10	286	131	128	13250	TIV250
	280	10	319	146	144	17840	TIV280
	315	10	360	164	162	25300	TIV315

I: IIP 122 F: AFNOR NF04 H: KIWA K5034 ND 10
*factor de seguridad reducido

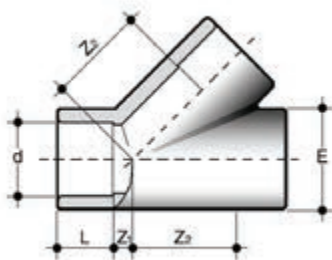

YIV

T a 45° con extremos para encolar hembra

d	PN	E	L	Z ₁	Z ₂	g	Código
20	16	27	16	7	30	39	YIV020
25	16	33	19	7	35	62	YIV025
32	16	41	22	9	44	110	YIV032
40	16	51	26	11	55	190	YIV040
50	16	63	31	12	68,5	335	YIV050
63	16	78	38	15	85	570	YIV063
**160	4	189	86	35	200	6500	YIV160

**producto comercializado

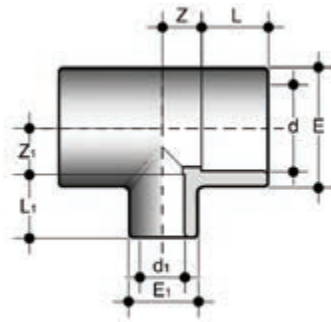

TRIV

T a 90° reducida con extremos para encolar hembra

d x d ₁	PN	E	E ₁	L	L ₁	Z	Z ₁	g	Código
25 x 20	16	33	28	19	16	14	14	37	TRIV025020
32 x 20	16	41	28	22	16	17,5	17,5	60	TRIV032020
32 x 25	16	41	34	22	19	17,5	17,5	65	TRIV032025
40 x 20	16	50	29	26	16	22	22	100	TRIV040020
40 x 25	16	50	34	26	19	22	22	100	TRIV040025
40 x 32	16	50	42	26	22	22	22	105	TRIV040032
50 x 20	16	61	30	31	16	27	27	160	TRIV050020
50 x 25	16	61	35	31	19	27	27	160	TRIV050025
50 x 32	16	61	42	31	22	27	27	165	TRIV050032
50 x 40	16	61	51	31	26	27	27	170	TRIV050040
63 x 25	16	76	36	38	19	33,5	33,5	290	TRIV063025
63 x 32	16	76	43	38	22	33,5	33,5	295	TRIV063032
63 x 40	16	76	52	38	26	33,5	33,5	300	TRIV063040
63 x 50	16	76	62	38	31	33,5	33,5	315	TRIV063050
75 x 32	16	91	41	44	22	40	40	530	TRIV075032
75 x 40	16	91	50	44	26	40	40	540	TRIV075040
75 x 50	16	91	61	44	31	40	40	550	TRIV075050
75 x 63	16	91	76	44	38	40	40	580	TRIV075063
90 x 40	16	109	50	51	26	48	48	870	TRIV090040
90 x 50	16	109	61	51	31	48	48	880	TRIV090050
90 x 63	16	109	76	51	38	48	48	900	TRIV090063
90 x 75	16	109	91	51	44	48	48	940	TRIV090075
110 x 50	16	133	61	61	31	61	61	1580	TRIV110050
110 x 63	16	133	76	61	38	61	61	1590	TRIV110063
110 x 75	16	133	91	61	44	61	61	1610	TRIV110075
110 x 90	16	133	109	61	51	61	61	1640	TRIV110090
**160 x 110	16	187	131	86	61	59	84	3450	TRIV160110
180 x 125	16	215	151	96	69	94	94	6760	TRIV180125
**250 x 110	4	285	134	129	63	61	128	8300	TRIV250110
**250 x 160	4	285	193	129	87	86	129	9900	TRIV250160
**250 x 200	4	285	228	129	106	133	132	12000	TRIV250200
**280 x 160	4	320	193	146	88	84	153	12500	TRIV280160
**280 x 225	4	320	258	146	117,5	117	150,5	14900	TRIV280225
**315 x 160	4	355	193	164	86	83	161	15000	TRIV315160
**315 x 200	4	355	228	164	106	102	179	17500	TRIV315200
**315 x 250	4	355	285	164	131	127	160	19200	TRIV315250

**producto comercializado

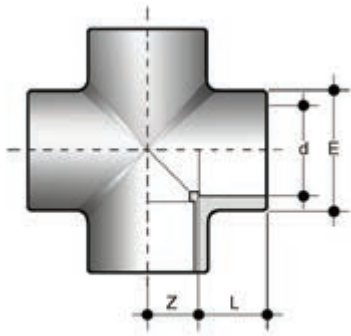

XIV

Cruz a 90° con extremos para encolar hembra

	d	PN	E	L	Z	g	Código
H	25	16	35	19	14	60	XIV025
H	32	16	43	22	18	105	XIV032
H	40	16	52	26	23	175	XIV040
H	50	16	64	31	27	265	XIV050
H	63	16	79	38	33,5	505	XIV063

H: KIWA K5034 ND 10

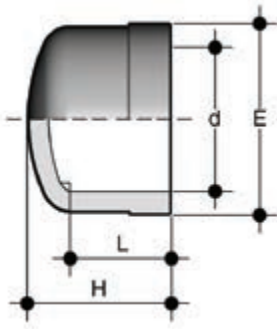

CIV

Tapón con extremo para encolar hembra

	d	PN	E	H	L	g	Código
	12	16	17	15	12	3	CIV012
F	16	16	21	17	15	4	CIV016
IF	20	16	28	23	16	9	CIV020
IF	25	16	34	27	19	15	CIV025
IF	32	16	41	31	22	25	CIV032
IF	40	16	51	36	26	40	CIV040
IF	50	16	62	43	31	60	CIV050
IF	63	16	77	51	38	110	CIV063
IF	75	16	91	59	44	190	CIV075
IF	90	16	110	69	51	330	CIV090
IF	110	16	133	85	61	575	CIV110
I	125	16	147	99	69	900	CIV125
	140	16	164	108	76	1100	CIV140
	160	16	192	128	86	1900	CIV160
	225	10	260	163	119	3000	CIV225

I: IIP 122 F: AFNOR NF04

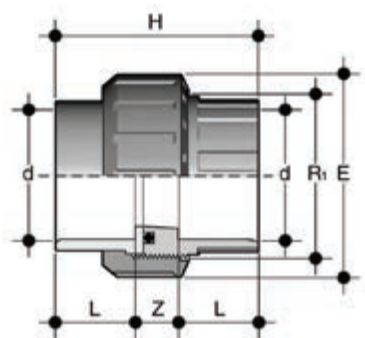

BIV

Unión 3 piezas con extremos para encolar hembra con junta tórica en EPDM o FPM

	d	R ₁	PN	E	H	L	Z	g	Código
I	16	3/4"	16	33	41	14	13	20	BIV016E
I	20	1"	16	41	45	16	13	35	BIV020E
I	25	1" 1/4	16	50	51	19	13	60	BIV025E
I	32	1" 1/2	16	58	57	22	13	85	BIV032E
I	40	2"	16	72	67	26	15	150	BIV040E
I	50	2" 1/4	16	79	79	31	17	175	BIV050E
I	63	2" 3/4	16	98	98	38	22	320	BIV063E
	75	3" 1/2	10	120	116	44	21	590	BIV075E
	90	4"	10	135	125	51	23	770	BIV090E
	110	5"	10	163	145	61	23	1300	BIV110E

I: IIP 122

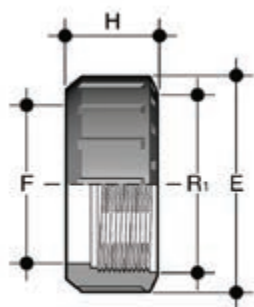

EFV

Tuerca con rosca hembra cilíndrica para uniones 3 piezas modelos BIV, BIFV, BFV, BLV, BIRV, BIFOV, BIROV, BIFXV, BIRXV.

R ₁	d BIV	PN	E	F	H	g	Código
3/8"	-	16	23	13	20	5	EFV038
1/2"	-	16	27	17	24	8	EFV012
3/4"	16	16	33	22	21	9	EFV034
1"	20	16	41	28	22	13	EFV100
1" 1/4	25	16	50	36	25	22	EFV114
1" 1/2	32	16	58	42	27	30	EFV112
2"	40	16	72	53	30	50	EFV200
2" 1/4	50	16	79	59	34	68	EFV214
2" 1/2	-	16	90	68	36	95	EFV212
2" 3/4	63	16	98	74	38	120	EFV234
3" 1/2	75	10	120	93	45	198	EFV312
4"	90	10	135	106	52	278	EFV400
5"	110	10	163	129	60	448	EFV500

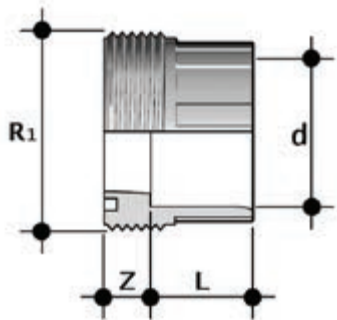

F/BIV

Parte fija para encolar hembra

d	R ₁	PN	L	Z	g	Código
16	3/4"	16	14	10	9	FBIV016
20	1"	16	16	10	13	FBIV020
25	1" 1/4	16	19	10	25	FBIV025
32	1" 1/2	16	22	10	31	FBIV032
40	2"	16	26	12	58	FBIV040
50	2" 1/4	16	31	14	63	FBIV050
63	2" 3/4	16	38	19	119	FBIV063
75	3" 1/2	10	44	18	230	FBIV075
90	4"	10	51	18	290	FBIV090
110	5"	10	61	18	500	FBIV110

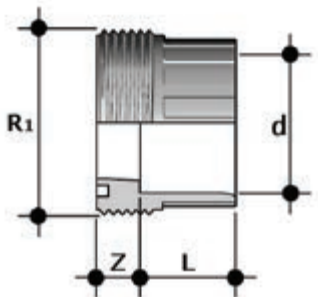

F/BLV

Parte fija para encolar hembra, serie BS

d	R ₁	PN	L	Z	g	Código
1/2"	1"	16	16	10	12,5	FBLV012
3/4"	1" 1/4	16	19	10	22,5	FBLV034
1"	1" 1/2	16	22	10	30	FBLV100
1" 1/4	2"	16	26	12	52	FBLV114
1" 1/2	2" 1/2	16	31	14	69,5	FBLV112
2"	2" 3/4	16	38	19	133,5	FBLV200

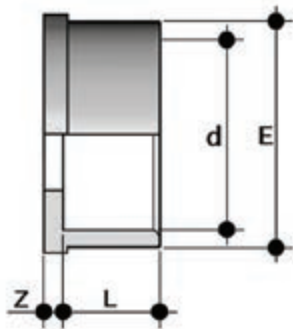

Q/BIV

Parte loca para encolar hembra, serie métrica

d	PN	E	L	Z	g	Código
16	16	22	14	3	5	QBIV016
20	16	28	16	3	8	QBIV020
25	16	36	19	3	15	QBIV025
32	16	42	22	3	24	QBIV032
40	16	53	26	3	37	QBIV040
50	16	59	31	3	42	QBIV050
63	16	74	38	3	77	QBIV063
75	10	93	44	3	150	QBIV075
90	10	105	51	5	192	QBIV090
110	10	129	61	5	335	QBIV110

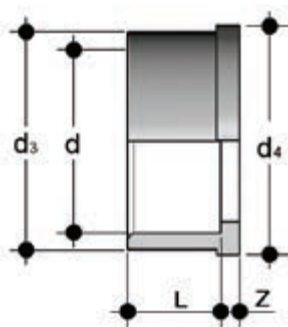

Q/BLV

Parte loca para encolar hembra, serie BS

d	PN	d ₃	d ₄	L	Z	g	Código
1/2"	16	27,5	30,1	16	3	8	QBLV012
3/4"	16	36	38,8	19	3	13	QBLV034
1"	16	41,5	44,7	22	3	19	QBLV100
1" 1/4	16	53	56,5	26	3	32	QBLV114
1" 1/2	16	59	62,6	31	3	46	QBLV112
2"	16	74	78,4	38	3	86	QBLV200

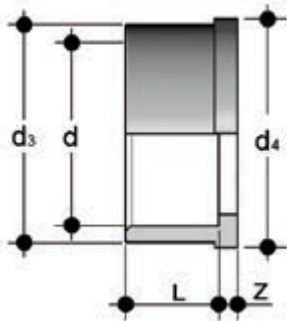

Q/BAV

Parte loca para encolar hembra, serie ASTM

d	PN	d_3	d_4	L	Z	g	Código
1/2"	16	27,5	30,1	22,7	3,5	15,5	QBAV012
3/4"	16	36	38,8	25,9	3,7	22,5	QBAV034
1"	16	41,5	44,7	29,2	3	32,5	QBAV100
1" 1/4	16	53	56,5	32	5	57	QBAV114
1" 1/2	16	59	62,6	35	5	78	QBAV112
2"	16	74	78,4	38,5	5,5	130	QBAV200

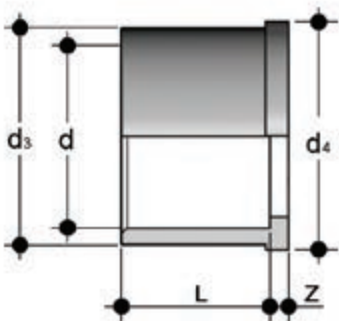

Q/BJV

Parte loca para encolar hembra, serie JIS

d	PN	d_3	d_4	L	Z	g	Código
1/2"	16	27,5	30,1	30	3	16	QBJV012
3/4"	16	36	38,8	35	3,5	21	QBJV034
1"	16	41,5	44,7	40	3	40	QBJV100
1" 1/4	16	53	56,5	44	3	68	QBJV114
1" 1/2	16	59	62,6	55	4,5	105	QBJV112
2"	16	74	78,4	62,9	5,5	175	QBJV200

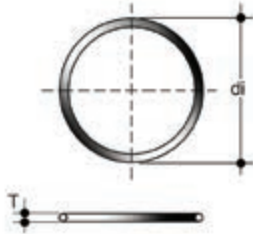

Juntas tóricas

Junta tórica para uniones 3 piezas modelos BIV, BIFV, BFV, BLV, BIRV, BIFOV, BIROV, BIFXV, BIRXV

Union d	C	de	T	Código EPDM	Código FPM
16	3062	15,54	2,62	OR3062E	OR3062F
20	4081	20,22	3,53	OR4081E	OR4081F
25	4112	28,17	3,53	OR4112E	OR4112F
32	4131	32,93	3,53	OR4131E	OR4131F
40	6162	40,65	5,34	OR6162E	OR6162F
50	6187	47	5,34	OR6187E	OR6187F
63	6237	59,69	5,34	OR6237E	OR6237F
75	6300	75,57	5,34	OR6300E	OR6300F
90	6362	91,45	5,34	OR6362E	OR6362F
110	6450	113,67	5,34	OR6450E	OR6450F

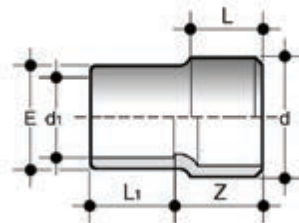

RIV

Reducción cónica con un extremo macho para encolar (d) o extremo hembra para encolar (d₁ reducido)

	d x d ₁	PN	E	L	L ₁	Z	g	Código
I	16 x 12	16	19	14	12	18	7	RIV016012
IF	20 x 16	16	22	16	14	21	8	RIV020016
F	160 x 110	16	137	86	61	125	1270	RIV160110
	200 x 160	10	182	106	86	156	2540	RIV200160

I: IIP 122 **F:** AFNOR NF04
RIV: las marcas de calidad se refieren a las distancias d y d₁

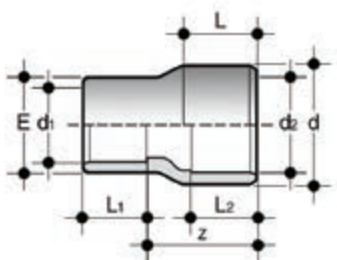

RIV

Reducción cónica con un extremo macho para encolar (d) o un extremo hembra para encolar (d_2), y otro extremo para encolar hembra (d_1 reducido)

	$d \times d_2 \times d_1$	PN	E	L	L_1	L_2	Z	g	Código
IF	25 x 20 x 16	16	22	19	14	16	24,5	9	RIV025020016
IF	25 x 20 x 20	16	26	19	16	16	24,5	12	RIV025020020
IF	32 x 25 x 16	16	22	22	14	19	30	14	RIV032025016
IF	32 x 25 x 20	16	27	22	16	19	30	16	RIV032025020
IF	32 x 25 x 25	16	32	22	19	19	30	20	RIV032025025
IF	40 x 32 x 20	16	27	26	16	22	36	23	RIV040032020
IF	40 x 32 x 25	16	32	26	19	22	36	27	RIV040032025
IF	40 x 32 x 32	16	41	26	22	22	36	34	RIV040032032
I	50 x 40 x 20	16	27	31	16	26	44	36	RIV050040020
IF	50 x 40 x 25	16	32	31	19	26	44	40	RIV050040025
IF	50 x 40 x 32	16	40	31	22	26	44	48	RIV050040032
IF	50 x 40 x 40	16	48	31	26	26	44	55	RIV050040040
I	63 x 50 x 25	16	32	38	19	31	54	75	RIV063050025
IF	63 x 50 x 32	16	40	38	22	31	54	80	RIV063050032
IF	63 x 50 x 40	16	49	38	26	31	54	90	RIV063050040
IF	63 x 50 x 50	16	60	38	31	31	54	110	RIV063050050
IF	75 x 63 x 50	16	61	44	31	38	62	130	RIV075063050
IF	75 x 63 x 63	16	76	44	38	38	62	175	RIV075063063
I	110 x 90 x 50	16	61	61	31	51	88	260	RIV110090050
I	110 x 90 x 63	16	76	61	38	51	88	300	RIV110090063
I	110 x 90 x 75	16	89	61	44	51	88	345	RIV110090075
IF	110 x 90 x 90	16	104	61	51	51	88	400	RIV110090090

I: IIP 122 F: AFNOR NF04

RIV: las marcas de calidad se refieren a las distancias d y d_1

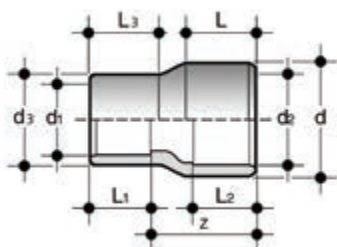

RIV

Reducción cónica con un extremo macho para encolar (d) o uno hembra para encolar (d_2), extremo con empalme hembra para encolar (d_1 reducido) o extremo macho para encolar (d_3 reducido)

	$d \times d_2 \times d_3 \times d_1$	PN	E	L	L_1	L_2	L_3	Z	g	Código
I	90 x 75 x 50 x 40	16	-	51	26	44	31	74	180	RIV090075050040
IF	90 x 75 x 63 x 50	16	-	51	31	44	38	74	200	RIV090075063050
IF	90 x 75 x 75 x 63	16	-	51	38	44	44	74	260	RIV090075075063
IF	90 x 75 x 90 x 75	16	-	51	44	44	51	74	325	RIV090075090075

I: IIP 122 F: AFNOR NF04

RIV: las marcas de calidad se refieren a las distancias d y d_1

Fig. A

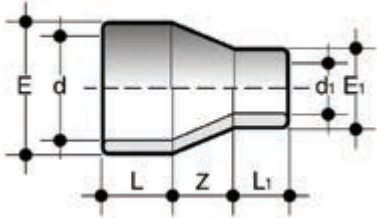

MRIV

Manguito reducido con extremos para encolar hembra (fig. A)

d x d ₁	PN	E	E ₁	K	L	L ₁	Z	g	Código
*180 x 125	4	214	154	-	95	68	48,8	2700	MRIV180125
*180 x 140	4	214	170	-	95	76	35	2700	MRIV180140
*180 x 160	4	214	190	-	95	86	17	2800	MRIV180160
*200 x 110	4	234	138	-	102	61	78	3100	MRIV200110
*200 x 125	4	234	154	-	102	68	65	3100	MRIV200125
*200 x 140	4	234	170	-	102	76	52	3200	MRIV200140
*200 x 160	4	234	190	-	102	86	35	3200	MRIV200160
*200 x 180	4	234	213	-	102	95	17	3300	MRIV200180
*225 x 110	4	258	138	-	103	62	100	4000	MRIV225110
*225 x 140	4	258	170	-	103	76	74	3800	MRIV225140
*225 x 160	4	258	190	-	103	86	57	4000	MRIV225160
*225 x 180	4	258	214	-	103	95	40	3500	MRIV225180
*225 x 200	4	258	234	-	103	102	22	3500	MRIV225200
*250 x 110	4	283	138	-	105	62	122	4500	MRIV250110
*250 x 125	4	283	154	-	105	68	108	4700	MRIV250125
*250 x 140	4	283	170	-	105	76	96	4600	MRIV250140
*250 x 160	4	283	190	-	105	86	78	4700	MRIV250160
*250 x 180	4	283	214	-	105	95	62	4600	MRIV250180
*250 x 200	4	283	234	-	105	102	44	4500	MRIV250200
*250 x 225	4	283	258	-	105	103	22	4900	MRIV250225
*280 x 110	4	317	138	-	101	62	150	5400	MRIV280110
*280 x 125	4	317	154	-	101	68	136	5400	MRIV280125
*280 x 140	4	317	170	-	101	76	123	5400	MRIV280140
*280 x 160	4	317	190	-	101	86	105	5700	MRIV280160
*280 x 180	4	317	214	-	101	95	87	5700	MRIV280180
*280 x 200	4	317	234	-	101	102	70	5800	MRIV280200
*280 x 225	4	317	258	-	101	103	47	5500	MRIV280225
*280 x 250	4	317	283	-	101	105	26	5400	MRIV280250
*315 x 160	4	355	190	-	105	86	135	6400	MRIV315160
*315 x 180	4	355	214	-	105	95	117	6600	MRIV315180
*315 x 200	4	355	234	-	105	102	100	6800	MRIV315200
*315 x 225	4	355	258	-	105	103	79	7200	MRIV315225
*315 x 250	4	355	283	-	105	105	57	6800	MRIV315250
*315 x 280	4	355	317	-	105	101	31	7100	MRIV315280
*355 x 315	4	394	355	-	105	105	35	7500	MRIV355315
*400 x 315	4	435	355	-	105	105	75	9500	MRIV400315
*400 x 355	4	435	394	-	105	105	40	9000	MRIV400355

*producto comercializado

Fig. B

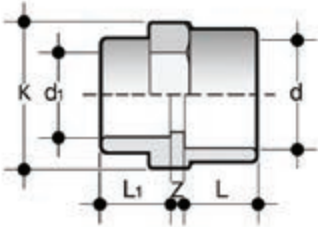

MRIV

Manguito reducido con extremos para encolar hembra (fig. B)

d x d ₁	PN	E	E ₁	K	L	L ₁	Z	g	Código
*110 x 90	16	-	-	130	61	51	4,5	555	MRIV110090

*factor de seguridad reducido

Fig. A

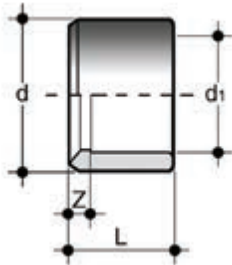

DIV

Casquillo reducción con un extremo macho para encolar (d) y otro hembra para encolar (d₁ reducido) (fig. A)

	d x d ₁	PN	L	Z	g	Código
	16 X 12	16	14	2	1	DIV016012
IF	20 X 16	16	16	2	3	DIV020016
IF	25 X 20	16	19	3	5	DIV025020
I	32 X 20	16	22	6	15	DIV032020
IF	32 X 25	16	22	3,5	10	DIV032025
IF	40 X 32	16	26	4	17	DIV040032
IF	50 X 40	16	31	5	32	DIV050040
IF	63 X 50	16	38	7	65	DIV063050
IF	75 X 63	16	44	6	85	DIV075063
IF	90 X 75	16	51	7	150	DIV090075
IF	110 X 90	16	61	9	270	DIV110090
IF	125 X 110	16	69	8	285	DIV125110
I	140 X 110	16	76	17	645	DIV140110
IF	140 X 125	16	76	9,5	350	DIV140125
IF	160 X 140	16	86	10	565	DIV160140
	*225 X 200	16	119	13	1380	DIV225200
	250 X 200	10	132	25	3500	DIV250200
	250 X 225	10	132	12	2100	DIV250225
	**280 x 250	4	147	15	2500	DIV280250
	315 x 280	10	165	18	4590	DIV315280

I: IIP 122 F: AFNOR NF04
 *factor de seguridad reducido
 **producto comercializado

Fig. B

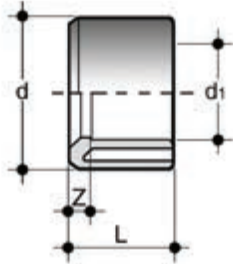

DIV

Casquillo reducción con un extremo macho para encolar (d) y otro hembra para encolar (d₁ reducido) (fig. B)

	d x d ₁	PN	L	Z	g	Código
I	40 X 20	16	26	9	25	DIV040020
I	40 X 25	16	26	7	24	DIV040025
I	50 X 32	16	31	8,5	35	DIV050032
I	63 X 32	16	38	16	73	DIV063032
I	63 X 40	16	38	11,5	75	DIV063040
I	75 X 50	16	44	13	120	DIV075050
I	90 X 50	16	51	20	200	DIV090050
I	90 X 63	16	51	13	210	DIV090063
I	110 X 63	16	61	23	340	DIV110063
I	110 X 75	16	61	17	360	DIV110075
I	140 X 90	16	76	25	730	DIV140090
I	160 X 90	16	86	35	1040	DIV160090
I	160 X 110	16	86	24	945	DIV160110
	*180 X 160	4	96	10	710	DIV180160
	*200 X 160	16	106	20	1310	DIV200160
	*200 X 180	4	106	10	870	DIV200180
	225 X 160	16	119	33	1840	DIV225160
	250 X 160	10	132	45	3100	DIV250160
	*250 X 180	4	132	36	3100	DIV250180
	*280 X 200	4	146	40	4100	DIV280200
	280 x 225	10	147	27	4300	DIV280225
	315 x 200	10	165	58	8650	DIV315200
	315 x 225	10	165	45	8100	DIV315225
	315 x 250	10	165	33	5080	DIV315250

I: IIP 122

*producto comercializado

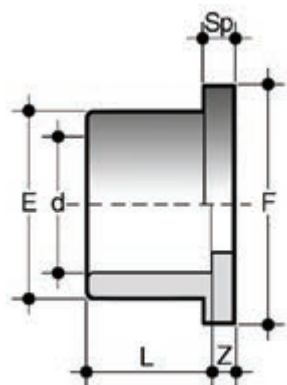

QPV

Manguito portabridas según normas DIN 8063 PN 10/16 con extremo para encolar hembra, superficies de apoyo planas

	d	DN	PN	E	F	L	Sp	Z	g	Código
I	20	15	16	27	34	16	7	3,5	10	QPV020
I	25	20	16	33	41	19	7	3	16	QPV025
I	32	25	16	41	50	22	7	3	25	QPV032
I	40	32	16	50	61	26	8	3	40	QPV040
I	50	40	16	61	73	31	8	3	62	QPV050
I	63	50	16	76	90	38	9	3	105	QPV063
I	75	65	16	90	105	44	10	3	160	QPV075
I	90	80	16	108	125	51	10	5	275	QPV090
I	110	100	16	131	150	61	12	4	445	QPV110
I	125	125	16	147	168	69	13	5	750	QPV125
I	125	***125	16	165	188	69	13	11	760	QPV125FKE
I	140	125	16	165	188	76	14	5	790	QPV140
	160	150	16	188	212	86	16	4,5	1140	QPV160
	200	***200	16	248	273	106	30	24	2700	QPV200FKE
	200	*200	16	230	254	106	18	5,5	1840	QPV200
	355	**350	4	386	413	184	29	8	5400	QPV355
	400	**400	4	430	483	206	26	12	6500	QPV400
	450	**450	4	486	538	-	19	8	5200	QPV450
	500	**500	4	532	574	-	18	-	3000	QPV500

I: IIP 122

*factor de seguridad reducido

**producto comercializado

***Portabridas especiales para válvulas de mariposa FK-FE

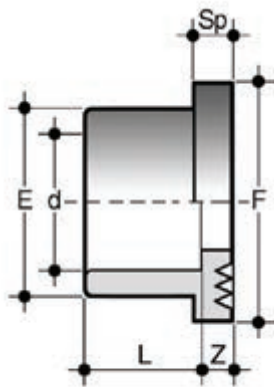

QRV

Manguito portabridas según normas DIN 8063 PN 10/16 con extremo para encolar hembra, superficie de apoyo estriada para portabridas QPV/QRV y juntas planas (para las dimensiones de las juntas ver QHV)

	d	DN	PN	E	F	L	Sp	Z	g	Código
I	40	32	16	50	61	26	8	3	40	QRV040
I	50	40	16	61	73	31	8	3	62	QRV050
I	63	50	16	76	90	38	9	3	105	QRV063
I	75	65	16	90	105	44	10	3	160	QRV075
I	90	80	16	108	125	51	10	5	275	QRV090
I	110	100	16	131	150	61	12	4	445	QRV110
I	125	125	16	147	168	69	13	5	750	QRV125
I	140	125	16	165	188	76	14	5	790	QRV140
I	160	150	16	188	212	86	16	4,5	1140	QRV160
	200	*200	16	230	254	106	18	5,5	1840	QRV200
	225	*200	16	245	273	119	25	5,5	1750	QRV225
	250	*250	16	270	306	131	20	8,5	2140	QRV250
	280	250	10	307	327	147	32	14,5	3650	QRV280
	315	300	10	346	377	165	32	16	4950	QRV315

I: IIP 122

*factor de seguridad reducido

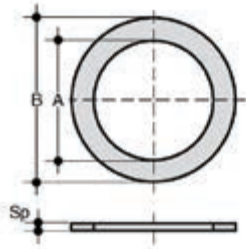

QHV/X

Junta plana de EPDM y FPM para portabridas según normas DIN 2501, EN1092

d	DN	A	B	Sp	Código EPDM	Código FPM
16	10	16	27	2	QHVX016E	QHVX016F
20 - 1/2"	15	20	32	2	QHVX020E	QHVX020F
25 - 3/4"	20	24	38,5	2	QHVX025E	QHVX025F
32 - 1"	25	32	48	2	QHVX032E	QHVX032F
40 - 1" 1/4	32	40	59	2	QHVX040E	QHVX040F
50 - 1" 1/2	40	50	71	2	QHVX050E	QHVX050F
63 - 2"	50	63	88	2	QHVX063E	QHVX063F
75 - 2" 1/2	65	75	104	2	QHVX075E	QHVX075F
90 - 3"	80	90	123	2	QHVX090E	QHVX090F
110 - 4"	100	110	148	3	QHVX110E	QHVX110F
125	125	125	166	3	QHVX125E	QHVX125F
140	125	140	186	3	QHVX140E	QHVX140F
160 - 6"	150	160	211	3	QHVX160E	QHVX160F
200	200	200	252	4	QHVX200E	-
225 - 8"	200	225	270	4	QHVX225E	-
250	250	250	305	4	QHVX250E	-

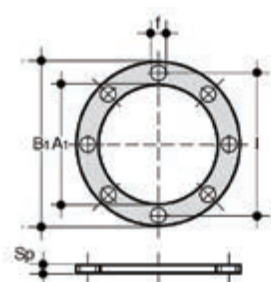

QHV/Y

Junta plana de EPDM para portabridas según norma DIN2501, EN1092, autocentrado para perforación PN10/16 hasta DN 150 y PN 10 de DN 200

d	DN	A ₁	B ₁	F	I	U	Sp	Código
16	10	-	-	-	-	-	-	-
20 - 1/2"	15	17	95	14	65	4	2	QHVV020E
25 - 3/4"	20	22	107	14	76,3	4	2	QHVV025E
32 - 1"	25	28	117	14	86,5	4	2	QHVV032E
40 - 1" 1/4	32	36	142,5	18	101	4	2	QHVV040E
50 - 1" 1/2	40	45	153,3	18	111	4	2	QHVV050E
63 - 2"	50	57	168	18	125,5	4	2	QHVV063E
75 - 2" 1/2	65	71	187,5	18	145,5	4	3	QHVV075E
90 - 3"	80	84	203	18	160	8	3	QHVV090E
110 - 4"	100	102	223	18	181	8	3	QHVV110E
125	125	132	250	18	210	8	3	QHVV125E
140	125	132	250	18	210	8	3	QHVV140E
160 - 6"	150	152	288,5	22	241,5	8	4	QHVV160E
200	200	192	340	22	295	8	4	QHVV200E
225 - 8"	200	215	340	22	295	8	4	QHVV225E
250	250	238	395	22	350	12	4	QHVV250E
280	250	265	395	22	350	12	4	QHVV280E
315	300	290	462	22	400	12	4	QHVV315E
355	350	337	500	22	460	16	2	QHVV355E
400	400	384	555	25	515	16	2	QHVV400E

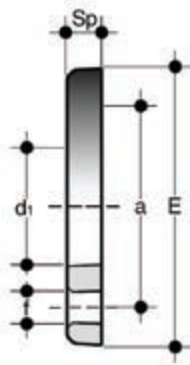

ODV

Brida loca para manguitos portabridas QPV, QRV, QLV EN/ISO/DIN
 Agujeros: - PN 10/16 hasta DN150 - PN 10 de DN200

	d	DN	*PMA (bar)	a	b	d ₁	E	f	Sp	U	** (Nm)	g	Código
I	20	15	10	65	M12 x 70	28	96	14	11	4	<10	60	ODV020
I	25	20	10	75	M12 x 70	34	107	14	12	4	<10	85	ODV025
I	32	25	10	85	M12 x 70	42	117	14	14	4	10	120	ODV032
I	40	32	10	100	M16 x 85	51	143	18	15	4	13	190	ODV040
I	50	40	10	110	M16 x 85	62	153	18	16	4	13	225	ODV050
I	63	50	10	125	M16 x 95	78	168	18	18	4	15	280	ODV063
I	75	65	10	145	M16 x 95	92	188	18	19	4	17	390	ODV075
I	90	80	10	160	M16 x 105	109	203	18	20	8	18	460	ODV090
I	110	100	10	180	M16 x 105	132	222	18	22	8	20	515	ODV110
I	125	125	10	210	M16 x 115	149	250	18	26	8	25	960	ODV125
I	140	125	10	210	M16 x 120	166	251	18	26	8	25	715	ODV140
I	160	150	10	240	M20 x 135	189	290	22	29	8	30	915	ODV160
I	200	200	10	295	M20 x 140	235	340	22	30	8	45	1210	ODV200
	225	200	10	295	M20 x 140	252	340	22	30	8	50	1090	ODV225
	250	250	10	350	M20 x 150	278	396	22	34	12	60	1790	ODV250
	280	250	10	350	M20 x 160	309	396	22	35	12	70	1880	ODV280
	315	300	10	400	M20 x 180	349	465	22	40	12	50	3050	ODV315
	355	***350	4	460	M20 x 180	386	505	22	32	16	70	3600	ODV355
	400	***400	4	515	M22 x 180	434	565	25	33	16	55	4500	ODV400
	450	***450	4	565	M22 x 160	489	615	25	32	20	65	4400	ODV450
	500	***500	4	600	M20 x 160	540	650	25	31	20	70	4200	ODV500

I: IIP 122

*PMA presión de funcionamiento máxima admisible

** momento de apriete nominal

***producto comercializado

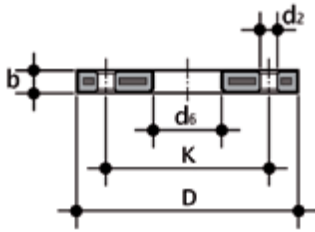

ODB

Brida loca de acero revestido de PP/FRP, según EN/ISO/DIN para manguitos portabridas QRV, QPV. Agujeros: PN 10/16 hasta DN 150; PN 10 de DN 200

d	DN	*PMA (bar)	b	d ₂	d ₆	D	k	M	n	** (Nm)	g	Código
20	15	16	12	14	28	95	65	M12	4	10	232	ODB020
25	20	16	14	14	34	105	75	M12	4	15	288	ODB025
32	25	16	14	14	42	115	85	M12	4	15	544	ODB032
40	32	16	16	18	51	140	100	M16	4	20	836	ODB040
50	40	16	16	18	62	150	110	M16	4	25	902	ODB050
63	50	16	19	18	78	165	125	M16	4	35	1074	ODB063
75	65	16	19	18	92	188	145	M16	4	40	1368	ODB075
90	80	16	21	18	109	204	160	M16	8	40	1516	ODB090
***125	100	16	22	18	135	224	180	M16	8	50	1938	ODB125
****180	150	16	27	22	191	285	240	M20	8	60	3298	ODB180
200	200	16	28	22	235	340	295	M20	8	75	5318	ODB200

* valores de máxima presión según EN/ISO/DIN. Prestar atención a los valores de máxima presión admisible para los asientos usados

**momento de apriete nominal

*** para utilizar con manguito portabridas QPV110, QRV110

**** para utilizar con manguito portabridas QPV160, QRV160,

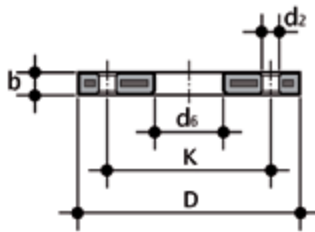

ODB-SW

Brida loca de acero revestido de PP/FRP, según EN/ISO/DIN para manguito portabridas QRV y QPV. Agujeros: PN 10/16 hasta DN 150; PN 10 de DN 200

d	DN	*PMA (bar)	b	d ₂	d ₆	D	k	M	n	** (Nm)	g	Código
140	125	16	24	18	166	252	210	M16	8	60	2965	SWODBD140DN125
225	200	16	27	22	247	340	295	M20	8	75	5060	SWODBD225DN200
280	250	16	30	22	309	395	350	M20	12	95	7112	SWODBD280DN250
315	300	16	34	22	349	445	400	M20	12	100	9468	SWODBD315DN300

*PMA presión de funcionamiento máxima admisible

**momento de apriete nominal

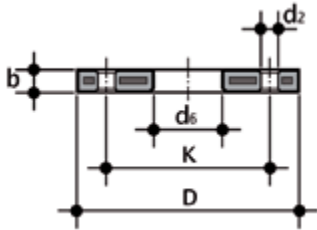

OAB

Brida loca de acero revestido de PP/FRP ANSI B16.5 cl.150 para manguito portabridas QRV, QPV

d mm	DN rosca	*PMA (bar)	b	d ₂ mm	d ₂ rosca	d ₆	D	k mm	k rosca	n	**(Nm)	g	Código
20	1/2"	16	12	16	5/8"	28	95	60,4	2" 3/8	4	15	200	OAB012
25	3/4"	16	12	16	5/8"	34	102	69,7	2" 3/4	4	15	240	OAB034
32	1"	16	16	16	5/8"	42	114	79,2	3" 1/8	4	15	490	OAB100
40	1" 1/4"	16	16	16	5/8"	51	130	88,7	3" 1/2	4	25	670	OAB114
50	1" 1/2"	16	18	16	5/8"	62	133	98,3	3" 7/8	4	35	640	OAB112
63	2"	16	18	20	3/4"	78	162	120,0	4" 3/4	4	35	1000	OAB200
75	2" 1/2"	16	18	20	3/4"	92	184	139,7	5" 1/2	4	40	1310	OAB212
90	3"	16	18	20	3/4"	111	194	152,4	6"	4	40	1250	OAB300
110	4"	16	18	20	3/4"	133	229	190,6	7" 1/2	8	40	1660	OAB400

*PMA: presión de funcionamiento máxima admisible
 **momento de apriete nominal

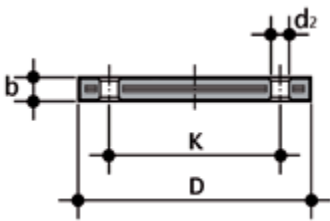

ODBC

Brida ciega de acero revestido de PP/FRP EN/ISO/DIN para manguito portabridas QRV, QPV Agujeros: PN 10/16 hasta DN 150; PN 10 de DN 200

d	DN	*PMA (bar)	b	d ₂	D	k	n	M	**(Nm)	g	Código
20	15	16	12	14	95	65	4	M12	15	290	ODBC020
25	20	16	12	14	105	75	4	M12	15	390	ODBC025
32	25	16	16	14	115	85	4	M12	15	520	ODBC032
40	32	16	16	18	140	100	4	M16	25	800	ODBC040
50	40	16	18	18	150	110	4	M16	35	940	ODBC050
63	50	16	18	18	165	125	4	M16	35	1150	ODBC063
75	65	16	18	18	185	145	4	M16	40	1640	ODBC075
90	80	16	18	18	200	160	8	M16	40	1960	ODBC090
110/125	100	16	18	18	220	180	8	M16	40	2720	ODBC110
140	125	16	24	18	250	210	8	M16	50	3920	ODBC140
160/180	150	16	24	22	285	240	8	M20	60	5060	ODBC160
200/225	200	16	24	22	340	295	8	M20	70	7800	ODBC200
250/280	250	10	30	22	400	350	12	M20	100	15400	ODBC250
315	300	10	34	22	463	400	12	M20	110	26000	ODBC315

* valores de máxima presión según EN/ISO/DIN. Prestar atención a los valores de máxima presión admisible para los asientos usados
 **momento de apriete nominal

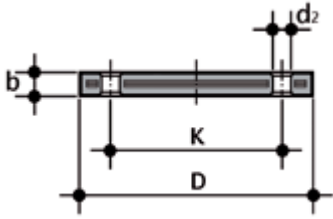

OABC

Brida ciega de acero revestido de PP/FRP ANSI B16.5 cl.150

rosca	DN	*PMA (bar)	b	d ₂ mm	d ₂ rosca	D	k mm	k rosca	n	** (Nm)	g	Código
1/2"	15	16	12	16	5/8"	95	60,45	2" 3/8	4	15	200	OABC012
3/4"	20	16	12	16	5/8"	102	69,85	2" 3/4	4	15	240	OABC034
1"	25	16	16	16	5/8"	114	79,25	3" 1/8	4	15	370	OABC100
1" 1/4	32	16	16	16	5/8"	130	88,90	3" 1/2	4	25	530	OABC114
1" 1/2	40	16	18	16	5/8"	133	98,55	3" 7/8	4	35	560	OABC112
2"	50	16	18	20	3/4"	162	120,65	4" 3/4	4	35	810	OABC200
2" 1/2	65	16	18	20	3/4"	184	139,70	5" 1/2	4	40	1070	OABC212
3"	80	16	18	20	3/4"	194	152,40	6"	4	40	1030	OABC300
4"	100	16	18	20	3/4"	229	190,50	7" 1/2	8	40	1570	OABC400

* PMA: presión de funcionamiento máxima admisible

**momento de apriete nominal

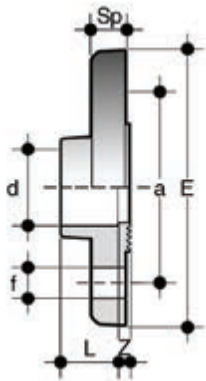

FDV

Brida con manguito para encolar hembra según norma EN/ISO/DIN, superficie de apoyo estriada para juntas planas (para las dimensiones de los asientos ver QHV)

Agujeros: PN 10/16 hasta DN 150; PN 10 de DN 200

d	DN	*PMA (bar)	a	E	f	L	Sp	Z	** (Nm)	g	Código
25	20	10	75	105	14	19	12	4,5	<10	105	FDV025
32	25	10	85	115	14	22	14	4,5	10	150	FDV032
40	32	10	100	140	18	26	15	4,5	13	230	FDV040
50	40	10	110	150	18	31	16	4,5	13	280	FDV050
63	50	10	125	163	18	38	18	4,5	15	390	FDV063
75	65	10	145	185	18	44	19	5	17	525	FDV075
90	80	10	160	200	18	51	20	7	18	710	FDV090
110	100	10	180	220	18	61	22	8	20	955	FDV110

* PMA: presión de funcionamiento máxima admisible

**momento de apriete nominal



FCV

Brida ciega con agujeros según norma EN/ISO/DIN superficie de apoyo estriada para juntas planas (para las dimensiones de las juntas ver QHV)
 Agujeros: PN 10/16 hasta DN 175; PN10 de DN 200

d	DN	*PMA (bar)	a	E	f	Sp	U	*** (Nm)	g	Código
25	20	10	75	105	14	12	4	<10	95	FCV025
32	25	10	85	115	14	14	4	10	135	FCV032
40	32	10	100	141	18	15	4	13	225	FCV040
50	40	10	110	150	18	16	4	13	270	FCV050
63	50	10	125	165	18	18	4	15	355	FCV063
75	65	10	145	186	18	19	4	17	510	FCV075
90	80	10	160	201	18	20	8	18	675	FCV090
110	100	10	180	221	18	22	8	20	915	FCV110
180	***175	4	270	315	22	30	8	45	3100	FCV180
200-225	***200	4	295	340	22	30	8	60	3800	FCV200

* PMA: presión de funcionamiento máxima admisible
 **momento de apriete nominal
 ***producto comercializado

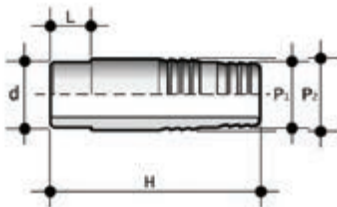

AIV

Espiga para encolar macho

d x P ₂ x P ₁	PN	H	L	g	Código
12 x 14 x 12	16	56	12	6	AIV012014012
16 x 18 x 16	16	60	14	12	AIV016018016
20 x 22 x 20	16	67	16	17	AIV020022020
25 x 27 x 25	16	81	19	26	AIV025027025
32 x 32 x 30	16	97	22	40	AIV032032030
40 x 42 x 40	16	104	26	78	AIV040042040
50 x 52 x 50	16	111	31	113	AIV050052050
63 x 64 x 60	16	123	38	170	AIV063064060

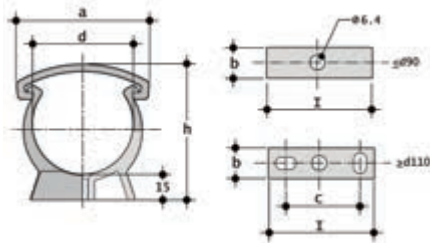

ZIKM

Abrazadera para tubería ISO-DIN de PP*

d	a	b	C	h	I	Código
**16	26	18	-	33	16	ZIKM016
**20	33	14	-	38	20	ZIKM020
**25	41	14	-	44	25	ZIKM025
**32	49	15	-	51	32	ZIKM032
**40	58	16	-	60	40	ZIKM040
**50	68	17	-	71	60	ZIKM050
**63	83	18	-	84	63	ZIKM063
**75	96	19	-	97	75	ZIKM075
**90	113	20	-	113	90	ZIKM090
**110	139	23	40	134	125	ZIKM110
**125	158	25	60	151	140	ZIKM125
**140	177	27	70	167	155	ZIKM140
**160	210	30	90	190	180	ZIKM160
**180	237	33	100	211	200	ZIKM180

*para las abrazaderas para tubería consultar las normas DVS 2210-1 (Planning and execution above-ground pipe system)
**producto comercializado

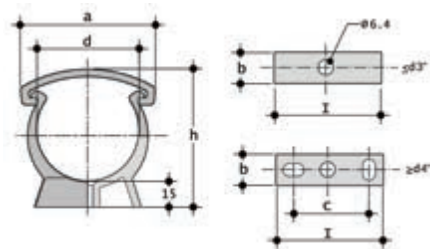

ZAKM

Abrazadera para tubería ASTM de PP*

d	a	b	C	h	I	Código
**3/8"	26	13	-	34	16	ZAKM038
**1/2"	33	14	-	39	20	ZAKM012
**3/4"	41	14	-	45	25	ZAKM034
**1"	49	15	-	52	32	ZAKM100
**1" 1/4	58	16	-	61	40	ZAKM114
**1" 1/2	68	17	-	67	50	ZAKM112
**2"	83	18	-	80	63	ZAKM200
**2" 1/2	96	19	-	96	75	ZAKM212
**3"	118	20	-	110	90	ZAKM300
**4"	140	25	60	135	140	ZAKM400
**6"	197	30	90	196	180	ZAKM600

*para los soportes para tubo consultar las normas DVS 2210-1 (Planning and execution above-ground pipe system)
**producto comercializado

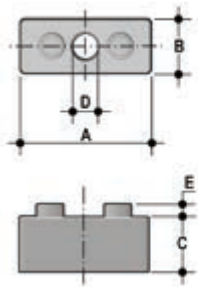

DSM

Distanciadores de PP para abrazaderas ZIKM*

d	A	B	C	D	E	Pack.	Master	Código
**32	33	16	14	8	4	20	120	DSM032
**40	41	17	17	8	4	10	80	DSM040
**50	51	18	17	8	4	10	50	DSM050
**63	64	19	22,5	8	4	10	40	DSM063
**75	76	20	34,5	8	4	10	40	DSM075

*para las abrazaderas para tubería consultar las normas DVS 2210-1 (Planning and execution above-ground pipe system)

**producto comercializado

INSTALACIÓN

COLOCACIÓN DE ABRAZADERAS PARA TUBERÍA (ZIKM Y ZAKM)

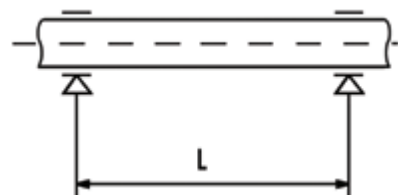

La instalación de tubos de material termoplástico requiere el uso de soportes para prevenir las flexiones y el consiguiente estrés mecánico.

La distancia entre los soportes depende del material, SDR, la temperatura superficial del tubo y la densidad del fluido.

Antes de realizar la instalación de los soportes, verificar las distancias que se indican en la siguiente tabla de acuerdo con las normas DVS 2210-01 para tuberías de conducción de agua.

Abrazaderas para tubos de PVC-U para el transporte de líquidos de una densidad de 1 g/cm³ (agua u otros fluidos)

Para tubos SDR 13,6 / S 6,3 / PN 16:

d mm	distancia L en mm a diferentes temperaturas de pared				
	≤ 20° C	30° C	40° C	50° C	60° C
16	950	900	850	750	600
20	1100	1050	1000	900	700

Para tubos SDR 21 / S 10 / PN 10:

d mm	distancia L en mm a diferentes temperaturas de pared				
	≤ 20° C	30° C	40° C	50° C	60° C
25	1200	1150	1050	950	750
32	1350	1300	1250	1100	900
40	1450	1400	1350	1250	1000
50	1600	1550	1500	1400	1150
63	1800	1750	1700	1550	1300
75	2000	1900	1850	1700	1450
90	2200	2100	2000	1850	1550
110	2400	2300	2250	2050	1750
125	2550	2450	2400	2200	1850
140	2700	2600	2500	2300	1950
160	2900	2800	2700	2500	2100
180	3100	2950	2850	2650	2200

En caso de SDR diferentes, multiplicar los datos que figuran en la tabla por los siguientes factores:
 1,08 para SDR13,6 / S6,3 / PN16 Gama dimensional d25 - d400
 1,15 para SDR11 / S5 / PN20 toda la Gama dimensional

Abrazaderas para tubos de PVC-U para el transporte de líquidos de una densidad diferente de 1 g/cm³

Si el líquido a transportar tiene una densidad diferente de 1 g/cm³, la distancia L de la tabla se debe multiplicar por los factores indicados en la tabla

Densidad del fluido en g/cm ³	Factor para abrazadera
1,25	0,96
1,50	0,92
< 0,01	1,42 para SDR21 / S10 / PN10 1,30 para SDR13,6 / S6,3 / PN16 1,20 para SDR11 / S5 / PN20



Aliaxis
UTILITIES & INDUSTRY

FIP Formatura Iniezione Polimeri

Loc. Pian di Parata, 16015 Casella Genova Italy

Tel. +39 010 9621.1

Fax +39 010 9621.209

info.fip@aliaxis.com

www.fipnet.com



Cód. LSRACCV 04/2016

