



VXE DN 65÷100
PVC-C

Easyfit 2-way ball valve

VXE DN 65÷100

FIP and Giugiaro Design designed and developed VXE Easyfit, the innovative True union ball valve with union nut tightening control system that permits simple and safe installation for reliable service in time. This valve is also equipped with the customisable Labelling System.

EASYFIT 2-WAY BALL VALVE

- **Patented Easyfit system:** innovative mechanism based on the multifunctional handle quick release mechanism that permits union nut rotation during valve installation and ball seat carrier adjustment
- Connection system for solvent weld and threaded joints
- **Valve material compatibility** (PVC-C) and elastomer **seal elements** (EPDM or FPM), with water, drinking water and other food substances as per **current regulations**
- Easy radial disassembly allowing quick replacement of O-rings and ball seats without any need for tools
- **PN16 True Union valve body** made for PVC-C injection moulding and European Directive 97/23/EC compliant for PED pressurised equipment. ISO 9393 compliant test requirements
- Valve body with built in anchoring frame for the special **Power Quick module** dedicated to accessory or pneumatic and electric actuator installation
- Option of disassembling downstream pipes with the valve in the closed position
- Floating **full bore ball** with high surface finish made in CNC work stations to achieve precise dimensional tolerance and high surface finish



Technical specifications	
Construction	Easyfit 2-way True Union ball valve with locked carrier
Size range	DN 65 ÷ 100
Nominal pressure	PN 16 with water at 20° C
Temperature range	0 °C ÷ 100 °C
Coupling standards	<p>Solvent welding: EN ISO 15493, ASTM F 439. Can be coupled to pipes according to EN ISO 15493, ASTM F 441</p> <p>Thread: ISO 228-1, DIN 2999, ASTM F437</p> <p>Flanging system: ISO 7005-1, EN ISO 15493, EN 558-1, DIN 2501, ANSI B.16.5 cl. 150, JIS B 2220</p>
Reference standards	<p>Construction criteria: EN ISO 16135, EN ISO 15493</p> <p>Test methods and requirements: ISO 9393</p> <p>Installation criteria: DVS 2204, DVS 2221, UNI 11242</p> <p>Actuator couplings: ISO 5211</p>
Valve material	PVC-C
Control options	Manual control, electric actuator, pneumatic actuator

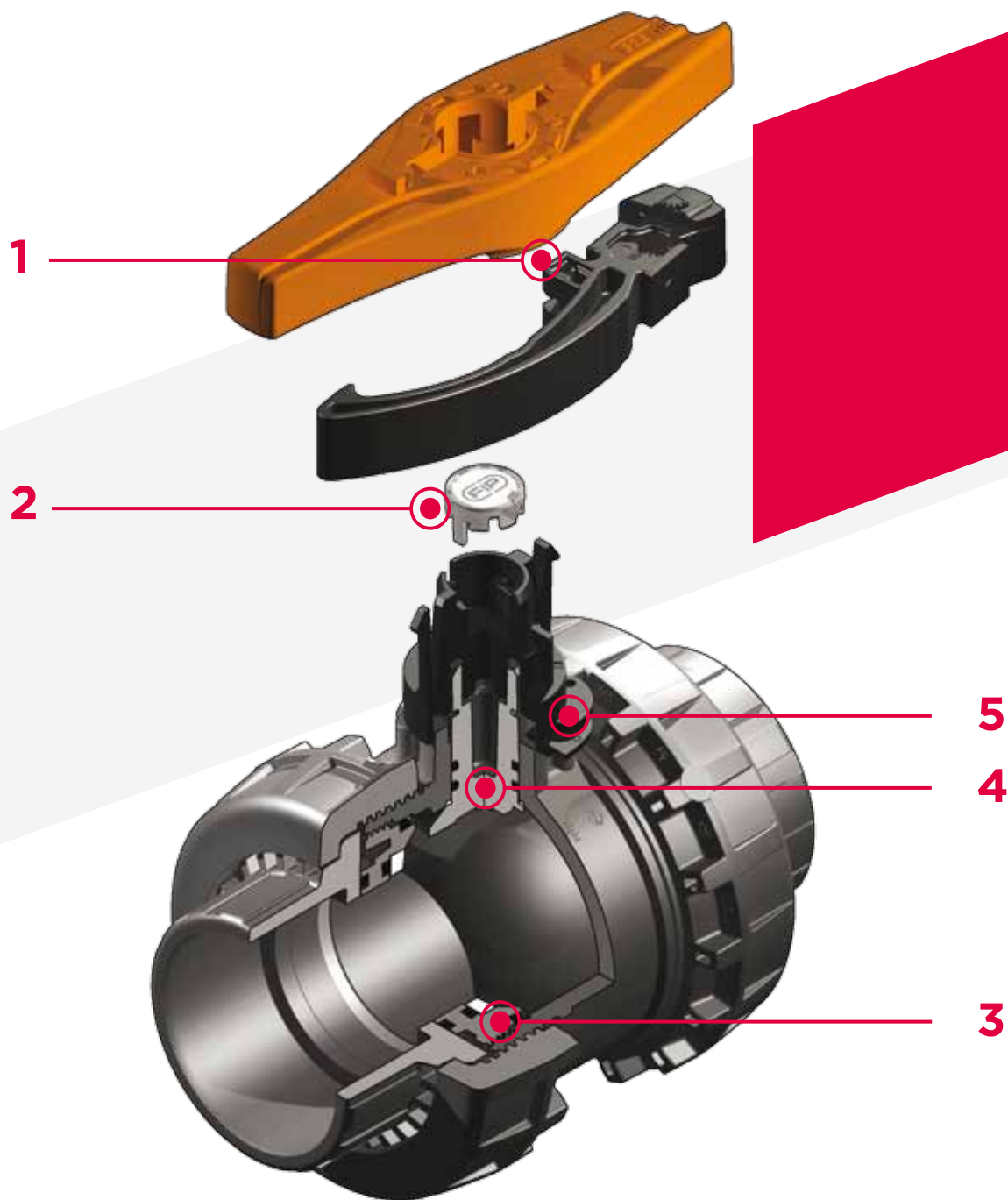

1 Innovative Easyfit quick release handle made up of a central hub firmly coupled with the stem valve and **dual spoke grip** that can be released from the hub with a simple operation and used as a **ball seat adjustment tool** and as a **union nut tightening tool** thanks to the hooked insert that, perfectly adapting to their external profile, allows the handle to transform into a wrench to control union nut rotation

2 Customisable Labelling System: built-in LCE module in the hub made up of transparent protection plug and customisable tag holder using the LSE set (available as accessory). The customisation lets you **identify the valve on the system according to specific needs**

3 PTFE ball seat system with locked carrier adjustable via the Easyfit quick release handle

4 Stem with high surface finish and **double O-Ring and PTFE anti-friction disk** that limits friction to a minimum and grants excellent operating torque

5 Locking device in closing and opening via lock

TECHNICAL DATA

PRESSURE VARIATION ACCORDING TO TEMPERATURE

For water and non-hazardous fluids to which the material is classified as CHEMICALLY RESISTANT. In other cases, a reduction of the nominal pressure PN is required (25 years with safety factor).

Note: When using PVC-C at working temperatures higher than 90°, it is advisable to first contact the service centre.

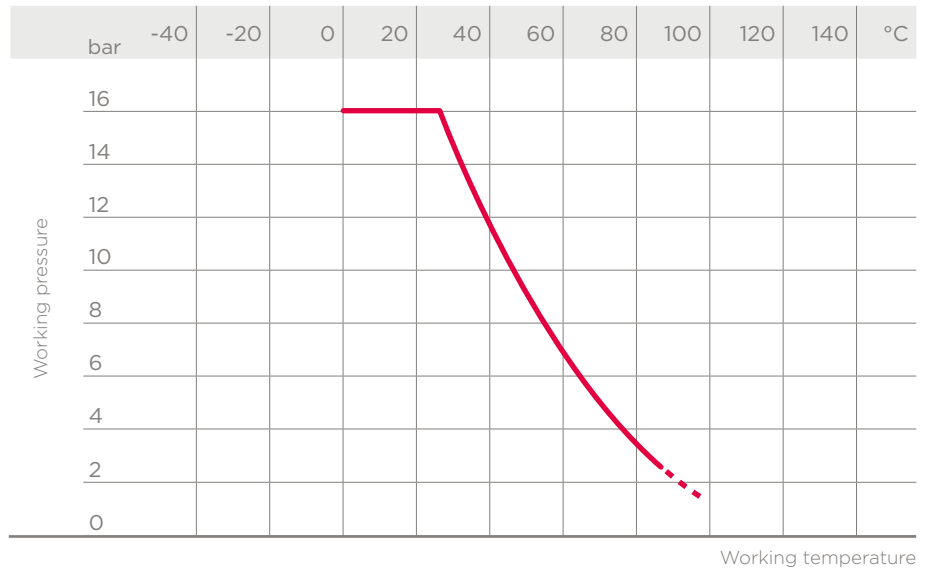

PRESSURE DROP GRAPH

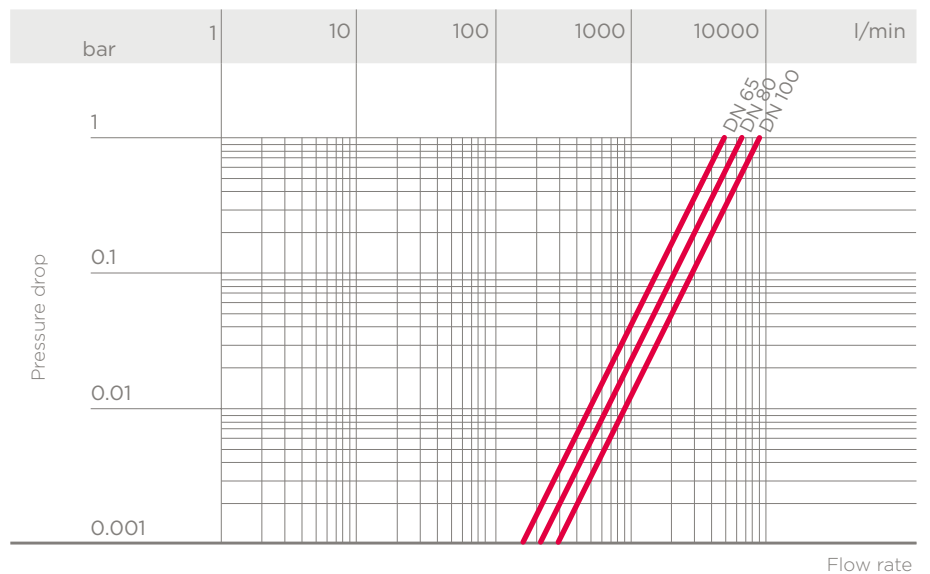

K_v100 FLOW COEFFICIENT

The K_v100 flow coefficient is the Q flow rate of litres per minute of water at a temperature of 20°C that will generate Δp= 1 bar pressure drop at a certain valve position.

The K_v100 values shown in the table are calculated with the valve completely open.

DN	65	80	100
K _v 100 l/min	5000	7000	9400

OPERATING TORQUE AT MAXIMUM WORKING PRESSURE

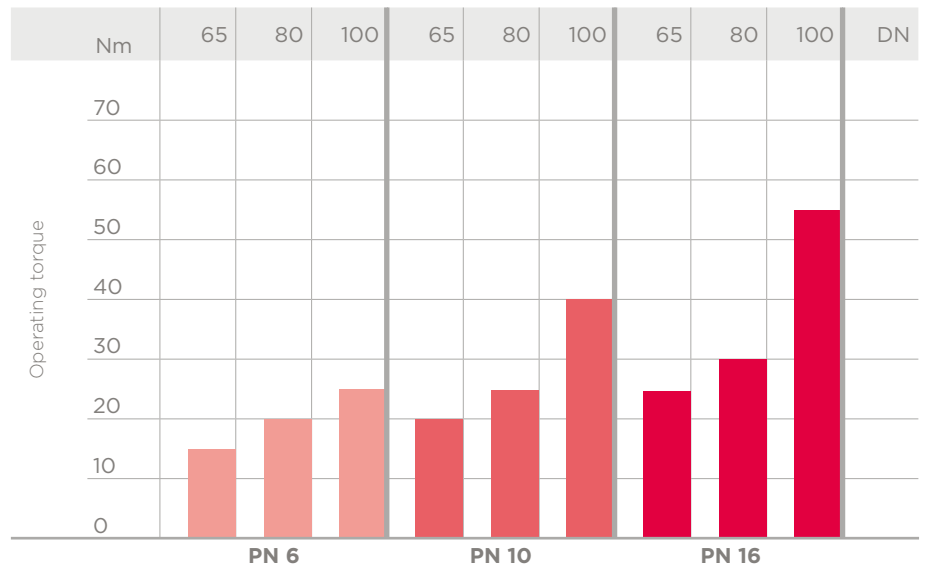

The information in this leaflet is provided in good faith. No liability will be accepted concerning technical data that is not directly covered by recognised international standards. FIP reserves the right to carry out any modification. Products must be installed and maintained by qualified personnel.

DIMENSIONS



VXEIC

Easyfit 2-way ball valve with female ends for solvent welding, metric series

d	DN	PN	B	C	C ₁	E	H	L	Z	g	EPDM Code	FPM Code
75	65	16	142	214	115	157	211	44	123	2998	VXEIC075E	VXEIC075F
90	80	16	151	239	126	174	248	51	146	3741	VXEIC090E	VXEIC090F
110	100	16	174.5	270	145	212	283	61	161	6337	VXEIC110E	VXEIC110F



VXEFC

Easyfit 2-way ball valve with BSP threaded female ends

R	DN	PN	B	C	C ₁	E	H	L	Z	g	EPDM Code	FPM Code
2" 1/2	65	16	142	214	115	157	211	30.2	150.6	2998	VXEFC212E	VXEFC212F
3"	80	16	151	239	126	174	248	33.3	181.4	3741	VXEFC300E	VXEFC300F
4"	100	16	174.5	270	145	212	283	39.3	204.4	6337	VXEFC400E	VXEFC400F



VXEAC

Easyfit 2-way ball valve with female ends for solvent welding, ASTM series

d	DN	PN	B	C	C ₁	E	H	L	Z	g	EPDM Code	FPM Code
2" 1/2	65	16	142	214	115	157	211	44.5	122	2998	VXEAC212E	VXEAC212F
3"	80	16	151	239	126	174	248	48	152	3741	VXEAC300E	VXEAC300F
4"	100	16	174.5	270	145	212	283	57.5	168	6337	VXEAC400E	VXEAC400F



VXENC

Easyfit 2-way ball valve with female ends, NPT thread

R	DN	PN	B	C	C ₁	E	H	L	Z	g	EPDM Code	FPM Code
2" 1/2	65	16	142	214	115	157	211	33.2	144.6	2998	VXENC212E	VXENC212F
3"	80	16	151	239	126	174	248	35.5	177	3741	VXENC300E	VXENC300F
4"	100	16	174.5	270	145	212	283	37.6	207.8	6337	VXENC400E	VXENC400F

ACCESSORIES

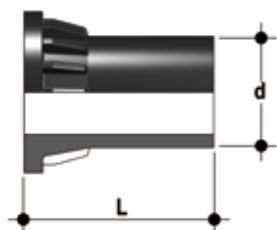

CVDE

Long spigot PE100 end connectors for joints with electrofusion fittings or for butt welding

d	DN	PN	L	SDR	Code
75	65	16	111	11	CVDE11075
90	80	16	118	11	CVDE11090VXE
110	100	16	127	11	CVDE11110VXE

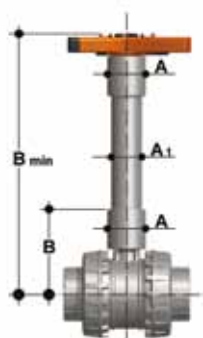

PSE

Stem extension

d	inch	DN	A	A ₁	B	B min	Code ISO pipe	Code ASTM-BS pipe
75	2"1/2	65	76	63	159	364	PSE090	PSE300
90	3"	80	76	63	166	371	PSE090	PSE300
110	4"	100	76	63	186	433	PSE110	PSE400



LCE

Transparent protection plug with tag holder

d	DN	Code
75	65	LCE040
90	80	LCE040
110	100	LCE040



LSE

Customisation and label printing set for Easyfit handle made up of pre-cut adhesive sheets and software for guided label creation.

d	DN	Code
75	65	LSE040
90	80	LSE040
110	100	LSE040

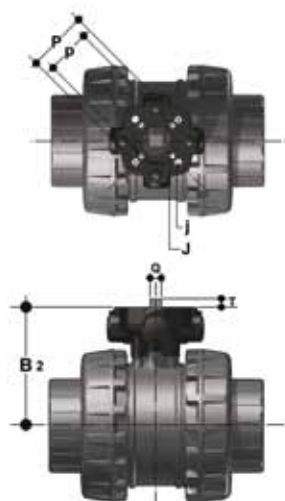

POWER QUICK EASYFIT

The valve can be equipped with pneumatic or electric standard actuators and gearbox for heavy-duty operations, using the PP-GR module reproducing the drilling pattern foreseen by ISO 5211.

d	DN	B ₂	Q	T	p x j	P x J	Code
75	65	129	14	16	F05 x 6,5	F07 x 8,5	PQE090
90	80	136	14	16	F05 x 6,5	F07 x 8,5	PQE090
110	100	156	17	19	F05 x 6,5	F07 x 8,5	PQE110



MSE

MSE is a limit switch box with electromechanical or inductive micro switches to remotely signal the valve position. Manual valve installation is possible using the Power Quick Easyfit actuation module.

The box can be assembled on the VXE valve even if already installed on the system.

d	DN	A	B	B ₁	Code electromechanical	Code inductive	Code Namur
75	65	139	203	79	MSE1M	MSE1I	MSE1N
90	80	146	210	87	MSE1M	MSE1I	MSE1N
110	100	166	231	106	MSE2M	MSE2I	MSE2N

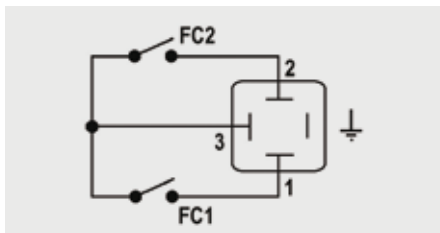

Electromechanical

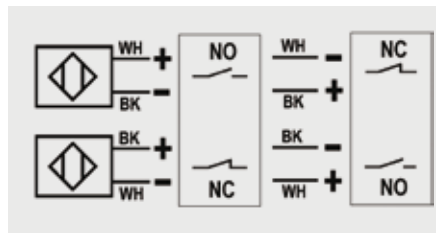

Inductive

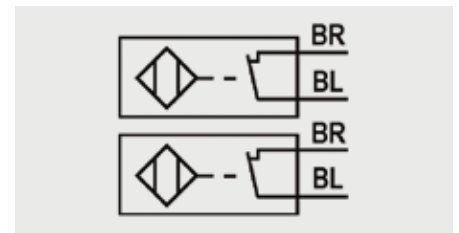

Namur

WH = white; BK = black; BL = blue; BR = brown

Type switches	Flow rate	Lifetime [drives]	Rated operating	Rated voltage	Operating current	Voltage drop	Empty current	Protection rate
Electromechanical	250 V - 5 A	3 x 10 ⁷	-	-	-	-	-	IP65
Inductive	-	-	5 ÷ 36 V	-	4 ÷ 200 mA	< 4,6 V	< 0,8 mA	IP65
Namur*	-	-	7,5 ÷ 30 V DC**	8,2 V DC	< 30 mA**	-	-	IP65

* To be used with an amplifier

** Outside areas with explosion risks

CUSTOMISATION

The VXE DN 65÷100 Easyfit valve is equipped with a customisable Labelling System.

This system lets you create special labels to insert in the handle. This makes it extremely easy to apply company logos, identification serial numbers or service indications such as, for example, the valve function in the system, the transported fluid, but also specific information for customer service, such as the customer name or installation date or location on the valves.

The specific LCE module is a standard supply and is made up of a rigid transparent water-resistant PVC plug (A) and white tag holder (B) made of the same material, one side of which bears the FIP logo (fig. 1).

The holder, inserted in the plug, can be removed and, once overturned, used for customisation by applying labels printed with the software supplied with the LSE set.

Proceed as follows to apply the label on the valve:

- 1) Release the handle from the central hub (C) and extract the transparent plug.
- 2) Extract the tag holder from the transparent plug (fig. 2).
- 3) Apply the adhesive label on the holder to align the profiles matching the tab position.
- 4) Reinsert the tag holder in the transparent plug so that the label is protected against the elements.
- 5) Apply the transparent plug on the central hub matching the two fittings (one narrow and one wide) with the relevant housings.

Fig. 1

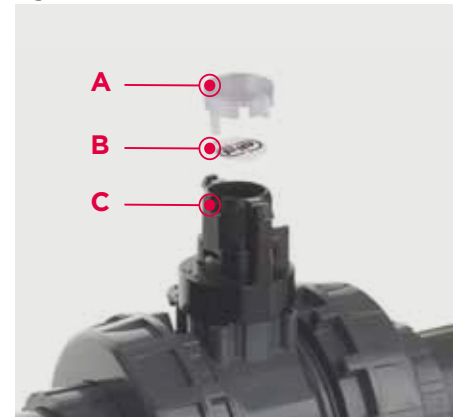
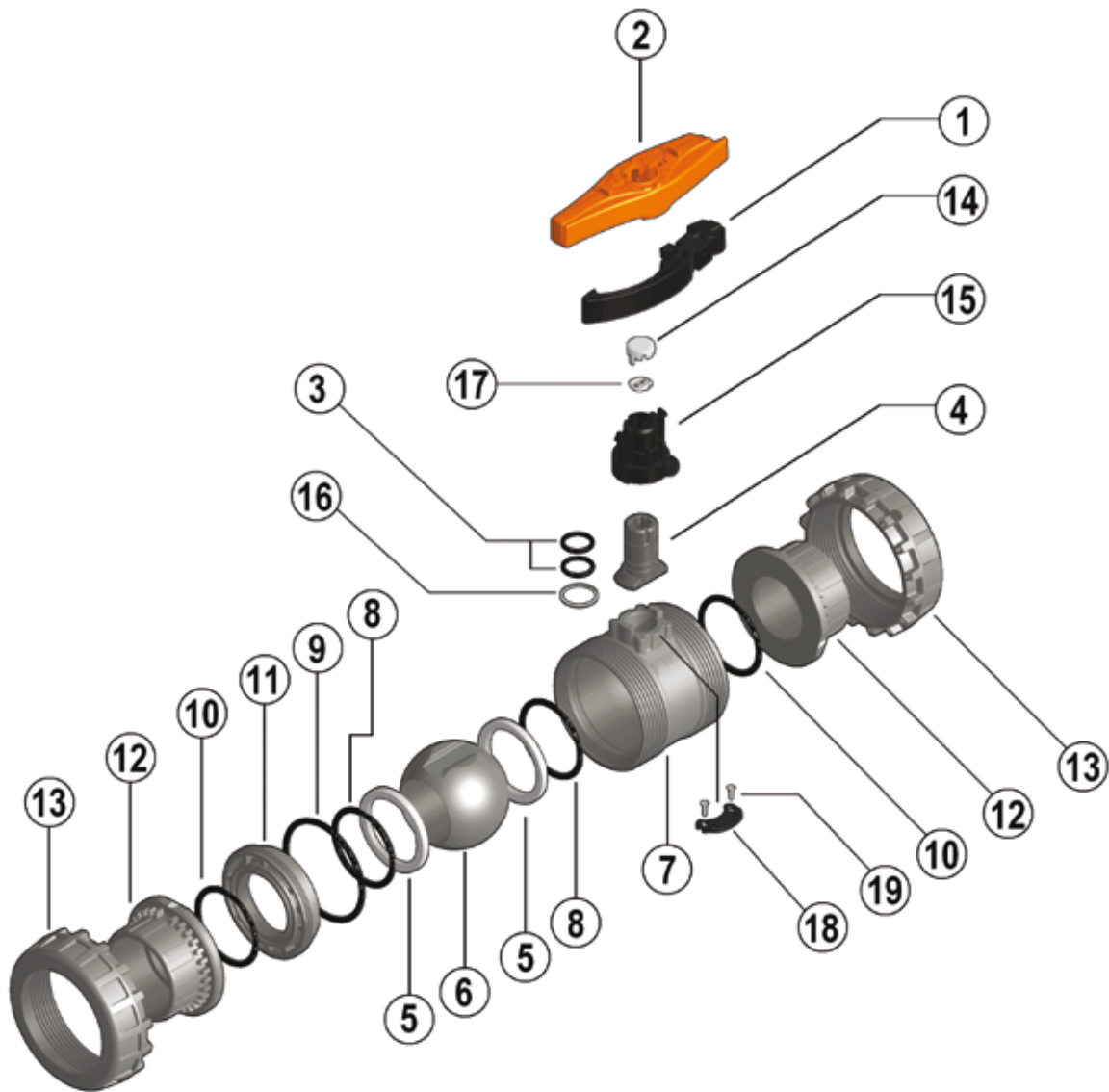

Fig. 2



COMPONENTS

EXPLODED VIEW



- 1** • Easyfit multifunctional handle insert hooked(PP-GR - 1)
- 2** • Easyfit multifunctional handle (HIPVC - 1)
- 3** • Stem O-Ring (EPDM or FPM - 2)*
- 4** • Stem (PVC-C - 1)
- 5** • Ball seat (PTFE - 2)*
- 6** • Ball (PVC-C - 1)*
- 7** • Body (PVC-C - 1)

- 8** • Ball seat O-Ring (EPDM or FPM - 2)*
- 9** • Radial seal O-Ring (EPDM or FPM - 1)*
- 10** • Socket seal O-Ring (EPDM or FPM - 2)*
- 11** • Ball seat carrier (PVC-C - 1)
- 12** • End connector (PVC-C - 2)
- 13** • Union nut(PVC-C - 2)
- 14** • Transparent protection plug (PVC - 1)

- 15** • Central hub (HIPVC - 1)
- 16** • Anti-friction disk (PTFE - 1)*
- 17** • Tag holder (PVC-U - 1)
- 18** • Locking device plate (HIPVC - 1)
- 19** • Self-threading screw (STAINLESS steel - 2)

* Spare parts

The material of the component and the quantity supplied are indicated between brackets

DISASSEMBLY

- 1) Isolate the valve from the line (release the pressure and empty the pipeline).
- 2) Extract the Easyfit multifunctional handle from the central hub pressing on the centre of the hub hinges (fig. 5) and use it as a wrench to fully unscrew the union nuts (13) from the valve body and slide the body out sideways (fig. 5).
- 3) Reposition the handle on the central hub.
- 4) Before disassembling, hold the valve in a vertical position and open it 45° to drain any liquid that might remain.
- 5) Open the valve.
- 6) Remove the ball seat carrier (11) using the Easyfit quick release handle. Insert the two protrusions at the top of the handle in the seat carriers (11) and unscrew, extracting it by turning counter-clockwise (fig. 6).
- 7) Press on the ball from the side opposite the "REGULAR" label, being sure not to scratch it, until the ball seat exits (5), then extract the ball (6).
- 8) Remove the central hub (15) firmly sliding it off the stem (4). Press the stem inwards and extract it from the body and remove the anti-friction disk (16).
- 9) Remove the O-Ring (3, 8, 9, 10) and ball seats (5) extracting them from their seats, as illustrated in the exploded view.

ASSEMBLY

- 1) All the O-rings (3, 8, 9, 10) must be inserted in their grooves as shown in the exploded view.
- 2) Place the anti-friction disk (16) on the stem (4) and insert it in the body (7).
- 3) Place the ball seats (5) in the housings in the body (7) and in the carrier (11).
- 4) Insert the ball (6) rotating it to the closed position.
- 5) Screw the carrier (11) into the body and tighten up in the clockwise direction using the handle (2) to limit stop.
- 6) Place the central hub (15) on the stem (4) firmly pressing down to match the internal hub key with one of the two seats on the stem.
- 7) Position the valve between the end connectors (12) and tighten the union nuts clockwise (13) using the Easyfit multifunctional handle (fig. 9) and being sure the socket seal O-rings (10) do not exit the seats.
- 8) Re-insert the hooked insert (1) in the housing on the handle (2).
- 9) Reposition the handle on the central hub making sure the two grooves in the central handle bore match the two grooves on the side of the hub and slightly press down until the two hinges click.



Note: during assembly, it is advisable to lubricate the rubber seals. Mineral oils are not recommended for this task as they react aggressively with EPDM rubber.

INSTALLATION

Before proceeding with installation, please follow these instructions carefully:

- 1) Check that the pipes to be connected to the valve are aligned in order to avoid mechanical stress on the threaded joints.
- 2) Unscrew the union nuts (13) from the body (7) and insert them in the pipe segments.
- 3) Solvent weld or screw the end connectors (12) onto the pipe segments.
- 4) Position the valve body between the end connectors.
Warning: if a high pressure test is required, always position the body with the "REGULAR" label upstream from the fluid direction.
- 5) Place the union nuts on the valve body and start tightening manually clockwise until they are hard to turn. To complete tightening, extract the Easyfit quick release multifunctional handle (2) pushing on the centre of the central hub hinges (15) (fig. 3 and 4)

Fig. 3



Fig. 4



Fig. 5



Fig. 6



- 6) Extract the hooked insert (1) in the handle (fig. 7) overturn it and fit it in the seat on the lower part of the handle (fig. 8).
- 7) Fit the tool (fig. 8) on the external union nut profile until firmly and safely secured, allowing for adequate torque without damaging the union nut in any way (fig. 9).
- 8) Repeat point 7 for the other union nut.
- 9) When tightened, remove the hooked insert and replace it in its seat in the handle.
- 10) Reposition the handle on the central hub making sure the two grooves in the central handle bore match the two grooves on the side of the hub and slightly press down until the two hinges click.
- 11) If necessary, support the pipe with FIP pipe clip model ZIKM and DSM spacers. The VXE valve is equipped with a locking device to protect the system against tampering (fig. 10).

WARNINGS

- If volatile liquid such as Hydrogen Peroxide (H₂O₂) or Sodium Hypochlorite (NaClO) are used, for safety reasons we recommend you contact the service centre. These liquids, upon vaporising, could create hazardous over pressures in the area between the body and ball.
- Always avoid sudden closing manoeuvres and protect the valve from accidental manoeuvres.

Fig. 7



Fig. 8



Fig. 9



Fig. 10

